

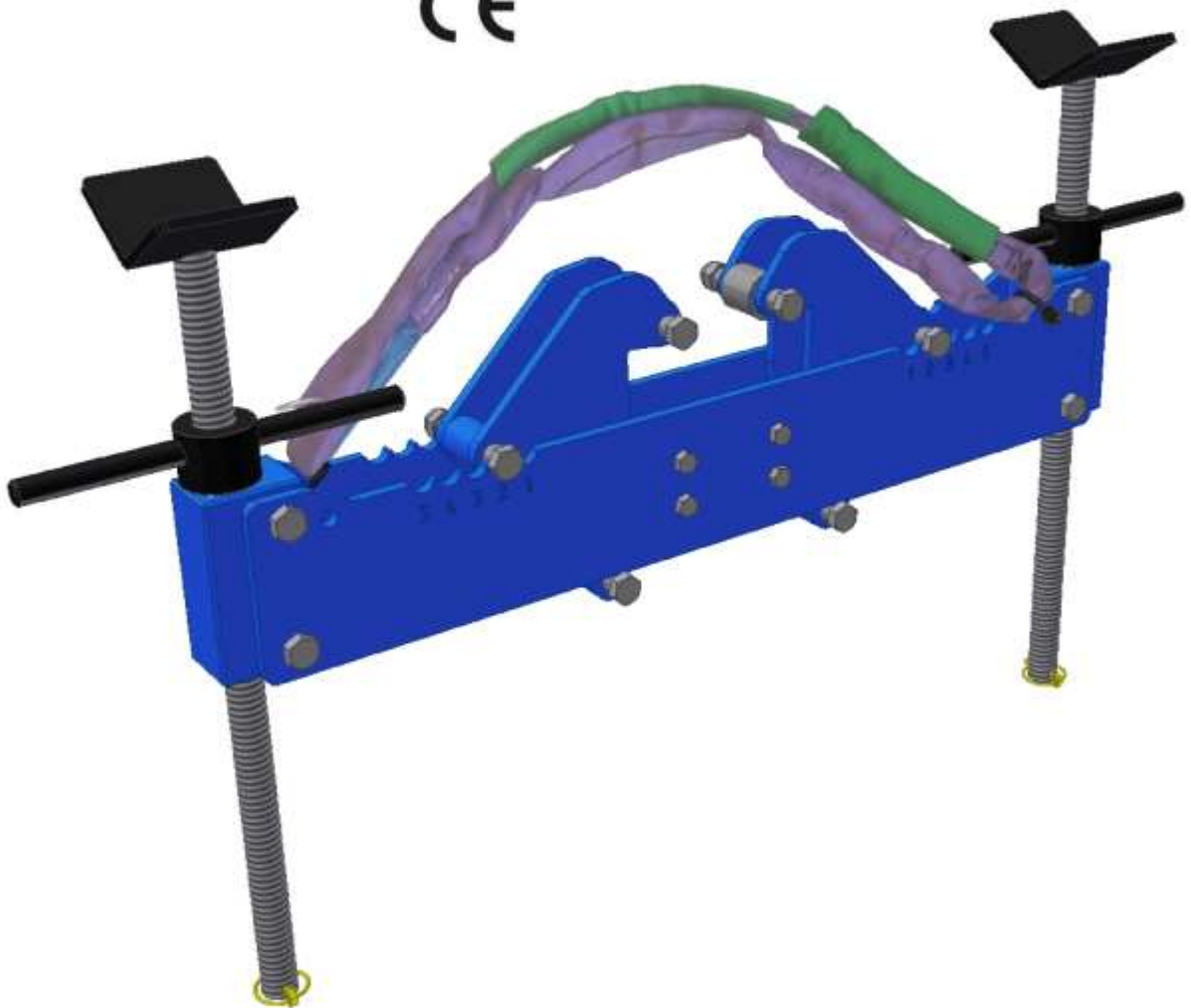

*Manual*

**PIPE RACK JACK** *type MS 1*

CE



## ***Dear customer,***

With the purchase of your PIPE RACK JACK (PRJ) you have become the owner of a high-performance and reliable pipe lifting system.

With correct use and regular maintenance your PIPE RACK JACK will tirelessly carry out heavy-duty work for many years.

This is a pipe lifting system specially designed for where other systems are too laborious, too expensive and require too much manpower.

## ***About this manual***

This user's manual contains all the necessary instructions for correct use and maintenance of your appliance. After following the instructions in the manual you can have any defective parts replaced free of charge during the guarantee period. Our distribution network is always there to assist you, not only for customer service but also for replacement parts and any further requirements you may have.

The illustration and text in this manual can differ slightly from your appliance. This is because for reasons of product improvement the manufacturer may have made technical or exterior adaptations without prior notification. Changes and errors reserved.

This manual was drawn up by the manufacturer and is supplied as standard with the machine. The content is intended for the user. The manual determines the scope of use of the machine and contains all the information needed for safe and correct use. Closely following the instructions in this manual guarantees the safety of the user and the machine, cost-effective operation and a long life for the machine. The most important aspects are summarised in separate sections. The table of contents quickly refers you to each subject.



### **Important:**

Refers to situations that can cause danger to persons, damage to the machine and/or the immediate vicinity or financial losses.



*Table of contents*

<b>1 Type designation of the appliance</b>	<b>4</b>
<b>2 Permissible uses</b>	<b>4</b>
<b>3 Safety instructions</b>	<b>5</b>
<b>4 Specifications</b>	<b>5</b>
4.1 Tool dimensions	6
4.2 Summary of the most important parts	7
<b>5 Use of the tool</b>	<b>8</b>
<b>6 Maintenance</b>	<b>10</b>
<b>7 Storage</b>	<b>10</b>
<b>8 Guarantee</b>	<b>10</b>
<b>9 EC declaration of conformity IIA</b>	<b>12</b>

## **1 Type designation of the appliance**

There is a type plate on the appliance. This shows the type designation, the article number and the most important technical information concerning the appliance. This plate must always be clean and readable.

## **2 Permissible uses**

The aluminium PIPE RACK JACK type MS1 is not a universal tool. It is only suitable for lifting pipes of metal, stainless steel, plastic and comparable materials.

**The PRJ type MS1 can be attached on profiles with height 100 up to 320 mm and flange width 100 up to 320 mm.**



**The PRJ may only be used when technically in perfect condition. Any faults must immediately be repaired. A user making his own adaptations to the appliance, use for other applications than the permitted one mentioned as well as not following the safety instructions or the instructions in this manual can cause damage to persons and objects. In these cases B&R Engineering can in no way whatsoever be held liable for injury or damage, and the machine guarantee will become inapplicable!**

**3**



**Read these safety instructions carefully before using or maintaining the PIPE RACK JACK.**

- This tool has been specially designed for lifting pipes and **MAY NOT** be used for any other purpose.
- Not paying attention to the warnings in this manual can result in personal injury and/or material damage.
- Study the aluminium PIPE RACK JACK and understand and follow all the instructions before you use this equipment.
- This PIPE RACK JACK is suitable for lifting a maximum of 2.5 tons. Do not exceed the nominal capacity. Overloading can cause damage to the PIPE RACK JACK.
- Do not make changes to this product.
- Inspect the PIPE RACK JACK before each time of using.
- Always wear safety glasses when using this product.

**4 Specifications**

- Maximum lifting capacity: 2.5 tons
- Operating temperature: -40°C to +100°C
- Lifting reach: at least 150 mm
- Dimensions: 926 x 278 x 120 mm
- Weight: 16.4 (body) + 4.6 (spindle 1) + 4.6 (spindle 2) = 25.6 kg

**4.1 Tool dimensions**

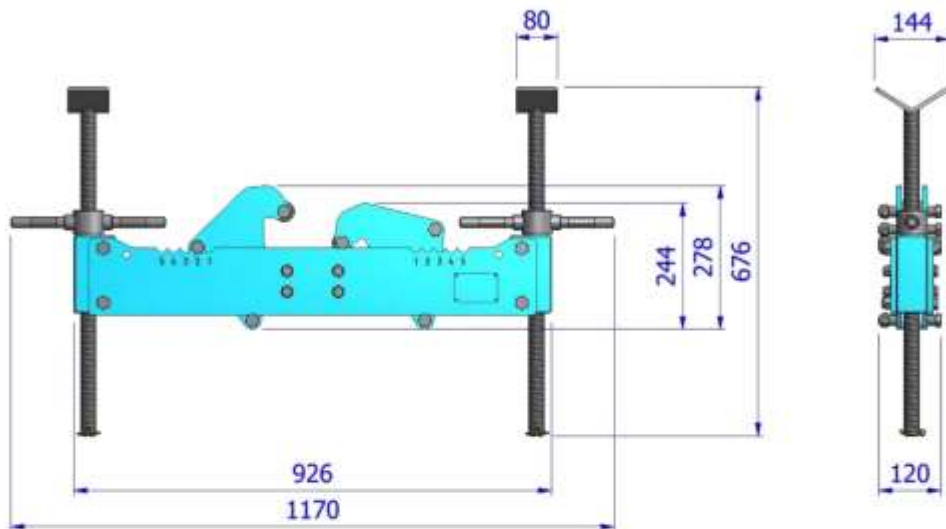

**4.2 Summary of the most important parts**

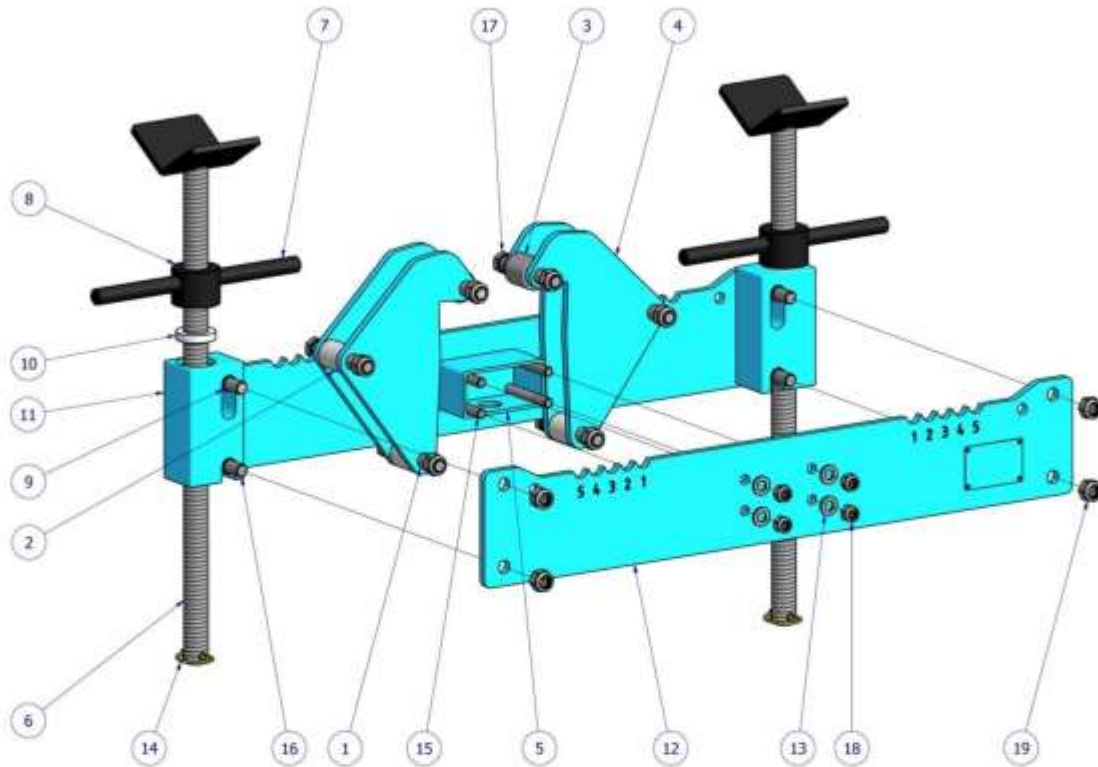

Pos.	Qty.	Part
1	12	PRJMS1 Clamping Jaw Bush 1 v1
2	4	PRJMS1 Clamping Jaw Bush 2 v1
3	2	PRJMS1 Clamping Jaw Bush 3 v1
4	4	PRJMS1 Clamping Jaw v1
5	1	PRJMS1 Centre Block v1
6	2	PRJMS1 Spindle Threaded Rod v1
7	4	PRJMS1 Spindle Handle v1
8	2	PRJMS1 Spindle Nut v1
9	4	PRJMS1 Spindle Holder Bush 1 v1
10	2	PRJMS1 Spindle Holder Bush 2 v1
11	2	PRJMS1 Spindle Holder v1
12	2	PRJMS1 Side Plate v1
13	8	Washer - DIN 125 - A 13
14	2	Springing securing pin d6
15	4	Hexagonal bolt - DIN 931-1 - M12 x 100
16	4	Hexagonal bolt - DIN 931-1 - M16 x 100
17	6	Hexagonal bolt - DIN 931-1 - M16 x 110
18	4	Hexagonal nut - DIN 985 - M12
19	10	Hexagonal nut - DIN 985 - M16

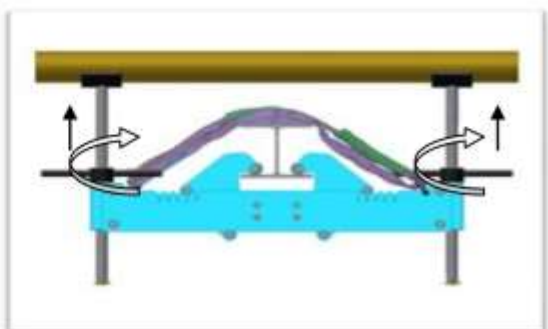
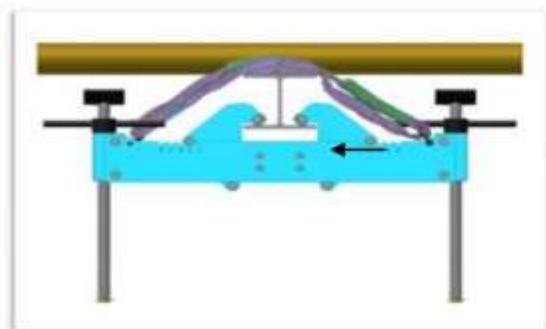
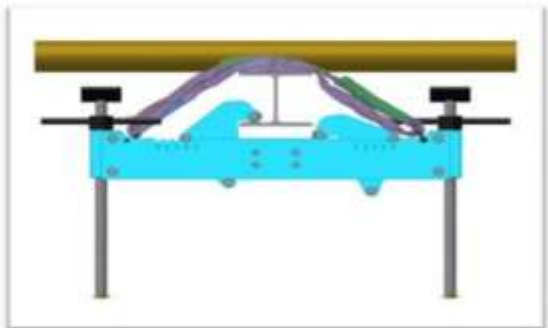
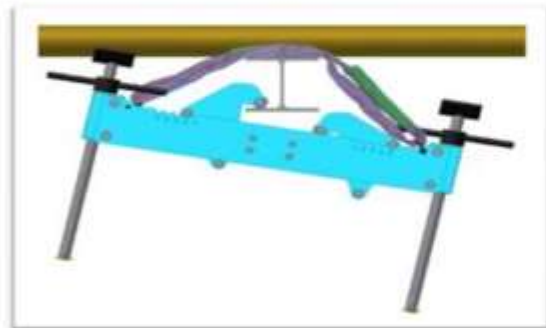
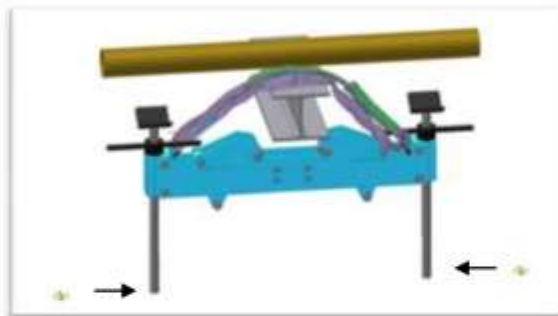
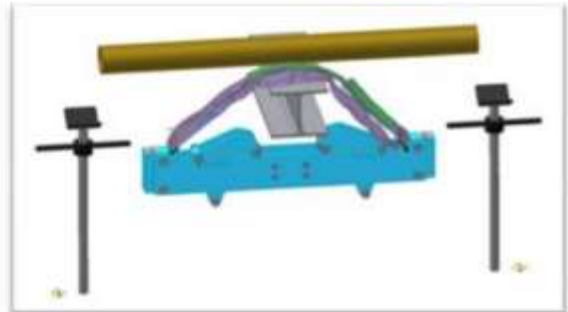



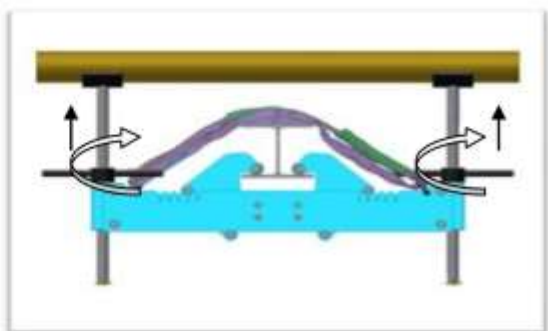
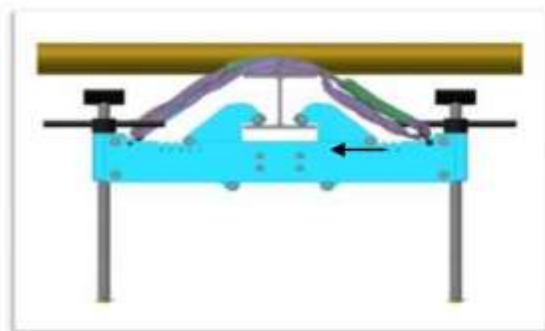
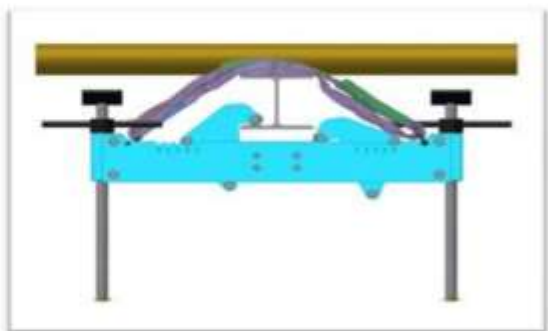
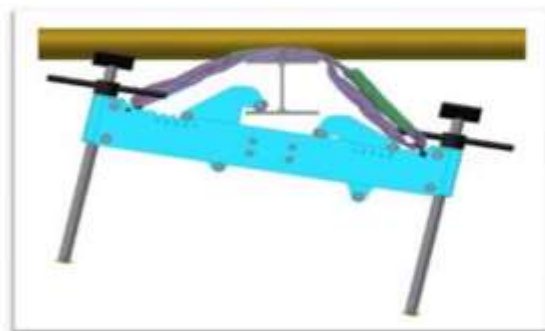
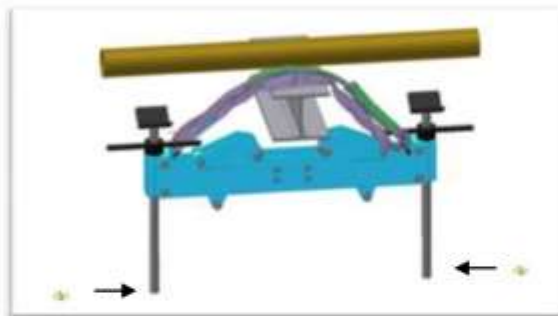
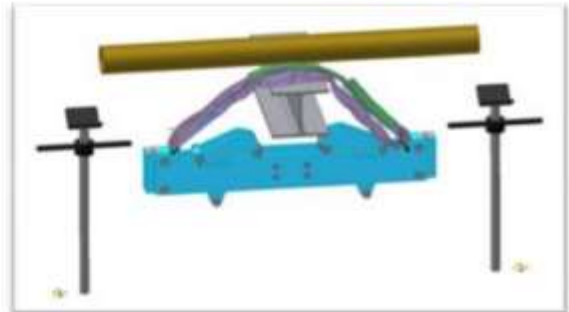



## **6 Maintenance**

Regularly treat the spindles with trapezoid thread with a good lubricant.

## **7 Storage**

Never leave the PIPE RACK JACK outdoors and make sure rain and snow cannot corrode the parts.

## **8 Guarantee**

In the case of a guarantee claim or repairs, please contact your professional vendor.

The purchaser is covered for hidden defects subject to the conditions below.

The guarantee period commences on the day of the risk transfer and expires two years after the risk transfer. You must demonstrate the date of purchase by means of the purchase agreement (delivery note). So keep this document very safely.

After the expiry of this period the purchaser can make no more claims whatsoever based on the guarantee.

The guarantee provides for free repairs (i.e. parts and working hours based on 'carry-in'), and should this be impossible free replacement with the taking back of the defective goods. There may be a waiting time for the purchaser depending on the availability of tools, parts and personnel.

The products of B&R ENGINEERING are not guaranteed and B&R ENGINEERING refuses any liability if the parts used are not original and not bought through B&R ENGINEERING.

Damage due to natural wear, transport damage, overloading and improper operation and handling is not covered by the guarantee.

The guarantee ends by right if the purchaser himself or a third party not approved by B&R makes any repairs or changes, and likewise if it is established that maintenance of the goods was not carried out in conformity with the instructions or if the product was not used in accordance with the manual and instruction provided.

The liability of B&R ENGINEERING is explicitly limited by the obligations above.



B&R ENGINEERING can only be held liable in the case of malicious intent or gross negligence. Its liability is in any event limited to the price of the defective part in the delivery, so as a result will never be able to exceed the invoiced amount. Indirect, immaterial or any other direct damage such as but not limited to loss of income and profits, loss of customers, loss of or damage to data, loss of contracts or supplementary costs are not covered by the guarantee.

B&R ENGINEERING cannot be held responsible for failures as a result of any Act of God.

**9 EC declaration of conformity IIA**



EC DECLARATION OF CONFORMITY  
ACCORDING TO ANNEX IIA

Machinery Directive 2006/42/EG

<u>Manufacturer:</u>	Name:	B&R Engineering
	Address:	Amerikalei 44, 2000 Antwerp
<u>Machine description:</u>	Name:	PIPE RACK JACK
	Type:	MS1
	Year of manufacture:	2012

The undersigned Paul Beelen and Ward Rombouts confirm on behalf of the company B&R Engineering that the machine described above, provided it has been installed, maintained and used in accordance with the instructions for use and the professional regulations, complies with the fundamental health and safety requirements of the Machinery Directive.

Date: 10 October 2011

Signature:



Undersigned: Paul Beelen  
Position: Business Manager  
Town/city: Antwerp

Signature:



Undersigned: Ward Rombouts  
Position: Business Manager  
Town/city: Antwerp